

# TYPE HOEKL125HAK (Talon)

## Dimension

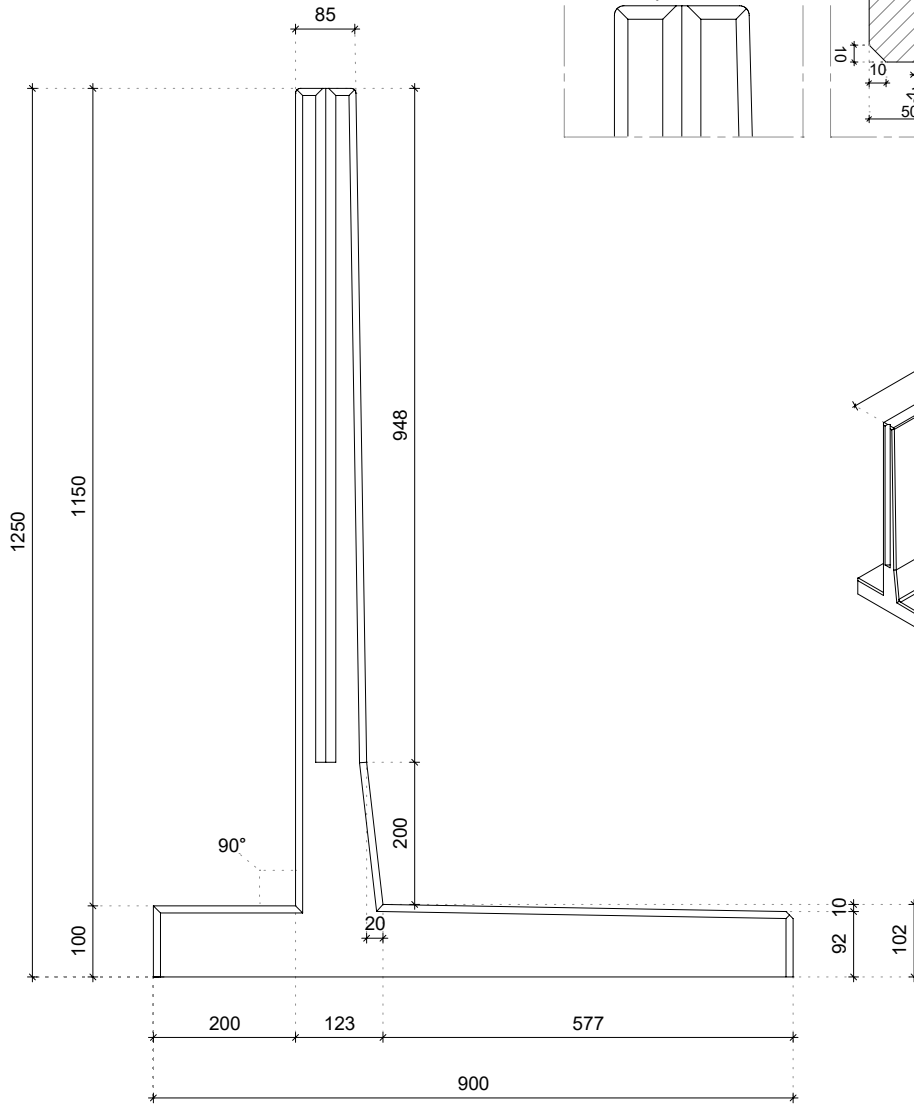

## Détails

### Dessus arrondi

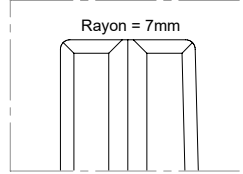

### Rainure en V

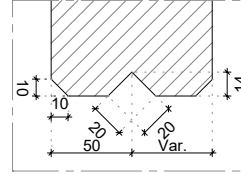

### Connexion des éléments

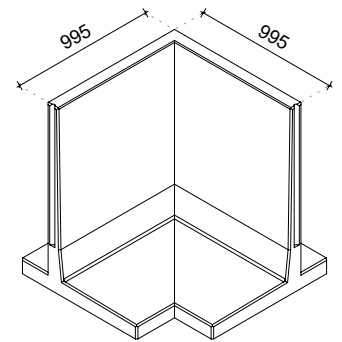
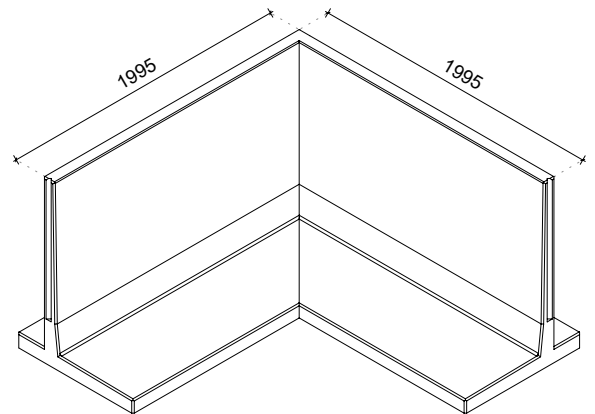
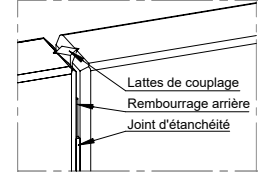

## Spécifications

Mélange de béton	3rd generation self-compacting C55/67
Armature en acier	B500
Poids	1725 kg (L = 1995x1995mm) 810 kg (L = 995x995mm)
Enrobage	30mm
Tolérance dimensionnelle	+/- 5mm
Classe visible de béton	Tous les côtés de visibilité A (supérieur)
Vie de conception	50 ans
Garantie du produit	10 ans
Classe écologique	XA3, XC4, XD3, XS3, XF4
Dispositif de levage	Aucun, endroits avec la pince

## Construit conformément à

NF-EN 1990 Eurocode 0	NF-EN 206
NF-EN 1991 Eurocode 1	Incl. annexes nationales
NF-EN 1992 Eurocode 2	
NF-EN 1997 Eurocode 7	

## Méthode de production



Énergie  
neutre



Eau de  
pluie filtrée



Matières premières  
durables



Matières  
recyclables

## Certifié

